

PosiTector® 6000 Series

Coating Thickness Gages for
ALL Metal Substrates



The Measure of Quality

PosiTector® 6000 Series

All Gages Feature...

Simple

- Ready to measure—no calibration adjustment required for most applications
- Enhanced one-handed menu navigation
- Flashing display—ideal in a noisy environment
- RESET feature instantly restores factory settings

Durable

- Solvent, acid, oil, water and dust resistant—weatherproof
- Wear-resistant probe tip
- Shock-absorbing, protective rubber holster with belt clip
- Two year warranty on gage body AND probe

Accurate

- Certificate of Calibration showing traceability to NIST included
- Built-in temperature compensation ensures measurement accuracy
- Hi-RES mode increases displayed resolution for use on applications that require greater precision
- Conforms to national and international standards including ISO and ASTM

Versatile

- Fully interchangeable probes are compatible with ALL gage bodies
- Multiple Calibration adjustment options including 1 point, 2 point, known thickness, average zero
- Selectable display languages
- Hi Contrast backlit display for bright or dark environments
- Flip display enables right-side-up viewing
- Extended cables available (up to 75 m/250 ft) for remote measuring
- Uses alkaline or rechargeable batteries (built-in charger)

Powerful

- Continually displays/updates average, standard deviation, min/max thickness and number of readings while measuring
- HiLo alarm audibly and visibly alerts when measurements exceed user-specified limits
- FAST mode—faster measurement speed for quick inspection
- USB port for fast, simple connection to a PC and to supply continuous power. USB cable included
- USB mass storage—stored readings and graphs can be accessed using universal PC/Mac web browsers or file explorers. No software required
- Every stored measurement is date and time stamped
- Software updates via web keep your gage current
- Connects to PosiTector.net (see far right panel)

Probes available for a variety of applications



For measuring paint, powder, etc. on all metals...



...and for measuring galvanizing, plating, anodizing and more.

Gage Selection...

Select Substrate

- F** — for ferrous metals (steel and cast iron)
- N** — for non-ferrous metals (aluminum, copper, etc.)
- FN** — for all metal substrates—Gage automatically recognizes the substrate and takes a measurement

Select Standard or Advanced Features

Standard Models

Includes ALL features as shown on left plus...

- Monochrome display
- Storage of 250 readings—stored readings can be viewed or downloaded

Advanced Models

Includes ALL features as shown on left plus...

- Hi Contrast reversible color LCD
- Storage of 100,000 readings in up to 1,000 batches and sub-batches
- Onscreen help, real time graphing, picture prompting and batch notes
- Data transfer via USB to a PC or via Bluetooth® Wireless Technology to a PC or printer
- Scan mode—take continuous readings without lifting the probe
- Multiple stored calibration adjustments for measuring on a variety of substrate conditions
- SSPC PA2 feature determines if film thickness over a large area conforms to user-specified min/max levels
- PSPC 90/10 feature determines if a coating system complies with an IMO performance standard for protective coatings

Select from a variety of measurement ranges and probe styles

(see back page ordering guide)

Heavy-duty, gold-plated locking connector for industrial environments



Removable Built-in Probe can be detached and replaced with any one of our wide variety of probes including separate probes and microprobes



FKS

90°

0°

45°

Regular

Rugged Features...

Sealed USB Port for communicating with a PC or Mac

Water and dust resistant—weatherproof

Hi resolution color LCD

Scratch/solvent/impact resistant lens

Multi-function navigation button

Solvent, acid, oil resistant, hi-grade, industrial strength housing

Advanced Model shown in Memory Mode

Quality high-flex cable and strain relief

Stainless steel probe with knurled finger grip

Strong wear-resistant ruby-tipped probe

All Regular Separate Probes are suitable for underwater use



where your gage meets the cloud™



A free web-based application offering secure centralized management of thickness readings

- Synchronize measurement data when connected via USB—measurements are uploaded to a secure server; images and batch notes are downloaded to your gage
- Manipulate uploaded data using a standard internet web browser from any location in the world—job site or head office
- Generate reports and graphs with annotations and user selected images
- Share measurement data with authorized users via a secure login from any computer and most web enabled devices
- Export data to XML and text files
- Visit www.defelsko.com/PosiTectorNET for a demonstration



Standard model shown in Statistics Mode with shock-absorbing, protective rubber holster













High-Range Probes for thick coatings, e.g. fire proofing, tank linings, etc.



Flip Display enables right-side-up viewing



Microprobe series for small parts and hard-to-reach areas

PosiTector® 6000 Series ORDERING GUIDE		Our most popular Removable Built-in and Regular Separate probe models			90° Regular probe for tight spots	Ideal for anodized aluminum	Microprobes – Our smallest probes for small parts or hard-to-reach areas			Removable Built-in and Separate probes for thick protective coatings; epoxy, rubber, intumescent fire proofing and more		
												
Non-Magnetic Coatings over FERROUS Metals (Steel and Iron)	Standard	F1	FS1	FRS1		FOS1	F45S1	F90S1	FT1	FTS1	FKS1	
	Advanced	F3	FS3	FRS3		FOS3	F45S3	F90S3	FT3	FTS3	FKS3	
Non-Conductive Coatings on NON-FERROUS Metals (Aluminum, Copper, etc.)	Standard	N1	NS1	NRS1	NAS1	NOS1	N45S1	N90S1			NKS1	
	Advanced	N3	NS3	NRS3	NAS3	NOS3	N45S3	N90S3			NKS3	
Combination ALL METALS	Standard	FN1	FNS1	FNRS1						FNTS1		
	Advanced	FN3	FNS3	FNRS3						FNTS3		
Range		0 – 60 mils 0 – 1500 µm			Ferrous: 0 – 45 mils and 0 – 1150 µm Non-Ferrous: 0 – 25 mils and 0 – 625 µm			0 – 250 mils 0 – 6 mm		0 – 500 mils 0 – 13 mm		
Accuracy*		±(0.05 mils + 1%) 0 – 2 mils ±(0.1 mils + 1%) > 2 mils ±(1 µm + 1%) 0 – 50 µm ±(2 µm + 1%) > 50 µm			±(0.02 mils + 1%) 0 – 4 mils ±(0.1 mils + 3%) > 4 mils ±(0.5 µm + 1%) 0 – 100 µm ±(2 µm + 3%) > 100 µm			±(0.5 mil + 1%) 0 – 100 mils ±(0.5 mil + 3%) > 100 mils ±(0.01 mm + 1%) 0 – 2.5 mm ±(0.01 mm + 3%) > 2.5 mm		±(1 mil + 3%) 0 – 500 mils ±(0.02 mm + 3%) 0 – 13 mm		
Matching DeFelsko Calibration Standards		STDS1 STDA1			STDS2 STDA2			STDP1		STDP5		

Probe Details

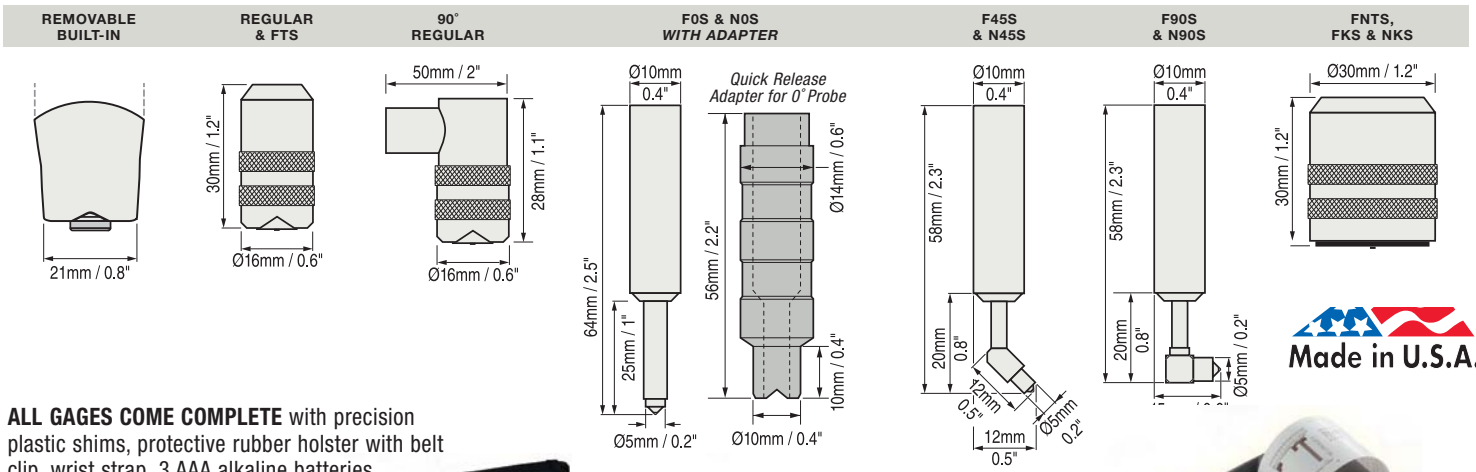

 Made in U.S.A.

ALL GAGES COME COMPLETE with precision plastic shims, protective rubber holster with belt clip, wrist strap, 3 AAA alkaline batteries, instructions, nylon carrying case with shoulder strap, protective lens shield, Long Form Certificate of Calibration traceable to NIST, USB cable, two (2) year warranty.

SIZE: 137 x 61 x 28 mm (5.4" x 2.4" x 1.1")

WEIGHT: 140 g (4.9 oz.) without batteries

Conforms to ISO 2178/2360/2808, PrEN ISO 19840, ASTM B499/D1186/D1400/D7091/E376/G12, BS3900-C5, SSPC-PA2 and others



Options

Bluetooth Printer receives data from Advanced models

AC Power Kit for continuous operation or battery charging—works in any country

Coating Thickness Standards to fulfill both ISO and in-house quality control requirements

Rechargeable Batteries—a set of eneloop NiMH AAA batteries

Protective Lens Shields protect the display from overspray

